

# PANEL-PIP

## Stylish Stainless Steel IP65 protected Panel PCs

### General Description

All PANEL-PIP's are especially designed and produced for rugged and sensitive environments like in medical and marine technologies, food industry as well as for industrial applications where quality is a major issue. Like all other MPL products the PANEL-PIP's come without a fan or air vents. They are very flexible and expandable for basically all customer needs and requirements.

The PANEL-PIP's are available in full stainless steel or chromated and externally powder coated aluminum housings. All combine a display with excellent optical specifications, a touch screen and a complete low power Pentium based Single Board Computer (PIP) to a silent, space-saving, easy-to-integrate and multifunctional All-in-One solution. The user selects depending on the application the display size (12" up to 19") as well as the required CPU computing power (5x86 up to Pentium M).

The complete PANEL-PIP is independent of the housing material, CPU board and display selection all around IP65 protected. The on-board available interfaces can be accessed externally via cables according the application needs. Via the PC/104 and PC/104-Plus additional features (e.g. WLAN, GPS...) can be added. All PANEL-PIP's can be mounted over a standard VESA connection on the wall, a swivel arm or an adjustable stand.

All PANEL-PIP's are fanless and noiseless and therefore the excellent solution for critical and reliable applications.

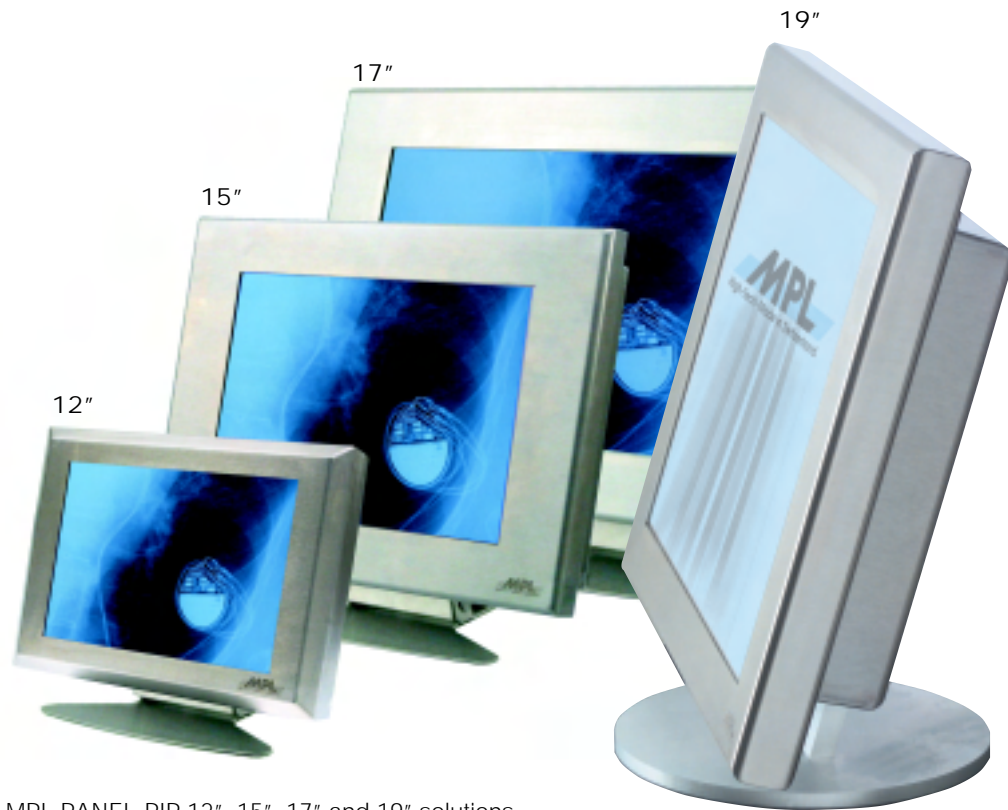

MPL PANEL-PIP 12", 15", 17" and 19" solutions



PANEL-PIP view from back with IP65 cable openings

# PANEL-PIP Data-Matrix

Panel Type	12"	15"	17"	19"
<b>Mechanical</b>				
Surface	Stainless steel or aluminum Antiglare protective glass			
Mounting Part	VESA 75	VESA 100	VESA 100	VESA 100
Protection class (from all sides)	IP 65/NEMA4	IP 65/NEMA4	IP 65/NEMA4	IP 65/NEMA4
Front Dimensions a x b x c (mm)	336 x 266 x 70	430 x 340 x 35	472 x 395 x 40	472 x 395 x 40
Back Dimensions d x e x f (mm)	no terrace	388 x 300 x 55	388 x 300 x 55	388 x 300 x 55
Display border g / h (mm)	43.8 / 39.5	62 / 54	66 / 62	47 / 46
Weight: S - all stainless steel (kg)	6.0	8.7	10.5	10.7
A - all aluminum (kg)	4.6	6.5	8.0	8.2

<b>Optical</b>				
Display Area (inches diagonal)	12.1"	15"	17"	19"
Resolution (pixel)	SVGA (800x600) or XGA (1024x768)	XGA (1024x768)	SXGA (1280x1024)	SXGA (1280x1024)
Color Depth	262k	16.2M	16.2M	16.2M
Contrast ratio	400:1	400:1	450:1	500:1
Brightness (cd/m <sup>2</sup> )	150	280	300	250
Viewing Angle (CR>10) right/left/up/down	80/80/80/80	89/89/89/89	75/75/75/55	85/85/85/85
Pixel Pitch (mm)	0.240 x 0.240	0.297 x 0.297	0.264 x 0.264	0.294 x 0.294

<b>Touch Option</b>				
Resistive Touch	yes	yes	yes	yes
	8-wire touchscreen, surface hard coating, antiglare treatment			
Touch controller	Resolution 1024 x 1024; standard over PS/2 (optional RS232 or USB interface)			
Driver Software	Available for DOS, Windows 9x, ME, XP, 2000, NT, CE and Linux			
Special	Touch and Mouse operation simultaneously possible			

<b>Physical</b>				
Power Supply	External 12 VDC Power Supply needed / external Power Supply (100-240 VAC) can be provided			
Options	IDE-Flash or HDD Add-on functionality over internal PC/104 or PC/104-Plus module			
Display & Inverter Power Consumption	10 W	20 W	26 W	32 W
Temperature Range	Stainless steel: 0°C up to +35°C, extended temperature on request Aluminum: 0°C up to +40°C, extended temperature on request			
Humidity	10% - 90% non condensing			

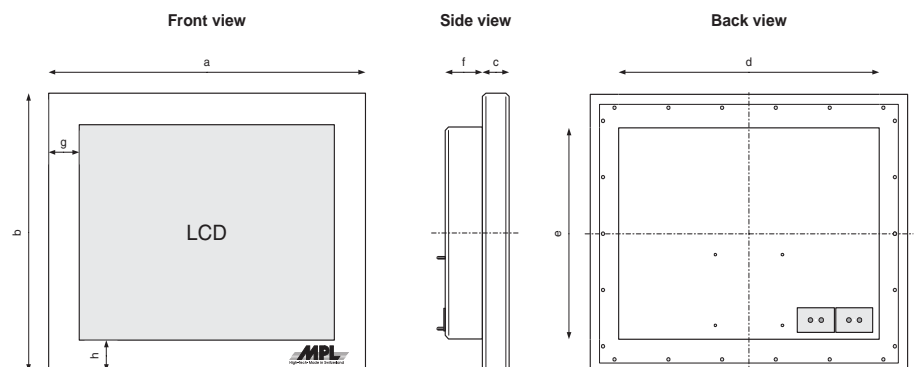

Täferstrasse 20  
 CH-5405 Baden-Dättwil  
 Tel. +41 (0)56 483 34 34  
 Fax +41 (0)56 493 30 20  
 Email: info@mpl.ch  
 Home page: www.mpl.ch

# CPU Versions

CPU	PIP5	PIP6	PIP7	PIP8	PIP9	PIP10
Processor	ELAN SC520 (Am5x86-133)	low power Pentium MMX	low power Pentium III	low power Pentium III	low power Pentium III	low power Pentium M
CPU speed	up to 133 MHz	up to 266 MHz	up to 400 MHz	up to 700 MHz	up to 933 MHz	up to 1.4 GHz
Memory	up to 256 MB	up to 256 MB	up to 256 MB	up to 256 MB	up to 1GB	up to 1.5 GHz
IDE	2 channels	2 channels	2 channels	2 channels	2 channels	2 channels
Keyboard	1 x PS/2	1 x PS/2	1 x PS/2	1 x PS/2	1 x PS/2	1 x PS/2
Mouse	1 x PS/2	1 x PS/2	1 x PS/2	1 x PS/2	1 x PS/2	1 x PS/2
Serial lines	4	4	4	4	up to 4	up to 4
Parallel port	1	1	1	1	1	1
USB 1.1/2.0	2/0	2/0	2/0	2/0	2/1*	0/3
CAN Bus 2.0	1	1	1	1	1*	1*
Ethernet	10/100TX port	10/100TX port	10/100TX port	10/100TX port	10/100TX port	10/100/1000TX port
Firewire	over PC/104-Plus	over PC/104-Plus	over PC/104-Plus	over PC/104-Plus	on-board 2 x up to 400MB/s	on-board 3 x up to 800MB/s
SCSI	1*	1*	1*	1*	optional	optional
Power Consumption	typically 7 Watts	typically 9 Watts	typically 14 Watts	typically 17 Watts	typically 20 Watts	typically 17 Watts
Expansion	over on-board PC/104 & PC/104-Plus or optional over standard PCI slots for all half size cards					

\* optional but on-board

## About MPL and MPL Products

MPL AG located Dättwil Switzerland near Zurich develops and manufactures for industrial needs Industrial PC's and systems with a high quality standard. They are in use practically in any part of the world. The strength of the enterprise are innovative solutions, low power consumption, long-term availability of the systems, customized solutions and the professional support that comes with each product.

The products and solutions are proven for use in rugged industrial environments, medical and marine technologies as well as in transportation and avionics.

MPL AG is an ISO 9001:2000 certified company



Täferstrasse 20  
CH-5405 Baden-Dättwil  
Tel. +41 (0)56 483 34 34  
Fax +41 (0)56 493 30 20  
Email: info@mpl.ch  
Home page: www.mpl.ch

### Industrial-PC Family (PIP)

Fanless solutions with Intel CPU's up to 1.4 GHz and PowerPC CPU. Numerous internal expansion possibilities such as PC/104, PC/104-Plus and PCI. Various EMI & RFI optimized housings.



### Industrial SBC-solutions (MIP)

Single Board Computers with Intel, PowerPC and ARM CPU's in various form factors (PC/104, PC/104-Plus and others).

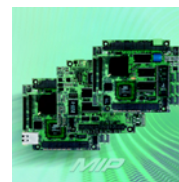

### Peripherals

PC/104 and PC/104-Plus peripheral solutions (e.g. Serial, USB2.0, FireWire, PCCard, Ethernet, Switch, CAN, Counter) UPS, Sound and Remote Man-Machine interfaces.



### Industrial PC-Module (IPM)

3U single Eurocards with Intel and Motorola CPU's (cPCI and G-96 Bus). Various peripheral cards and complete systems.

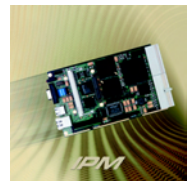

### PCMCIA Reader/Writers (MCDISK)

PCMCIA read-/write with SCSI or serial interface.



### Customer specific solutions (OEM)

Development of customized boards and semi custom solutions based on standard products, broad technology know-how, short development time and total support over product life time.



### Software solutions

Linux, Windows, DOS, Windows CE, RealTime OS and others. Driver for various operating systems.

# The unique rugged Industrial PC Concept

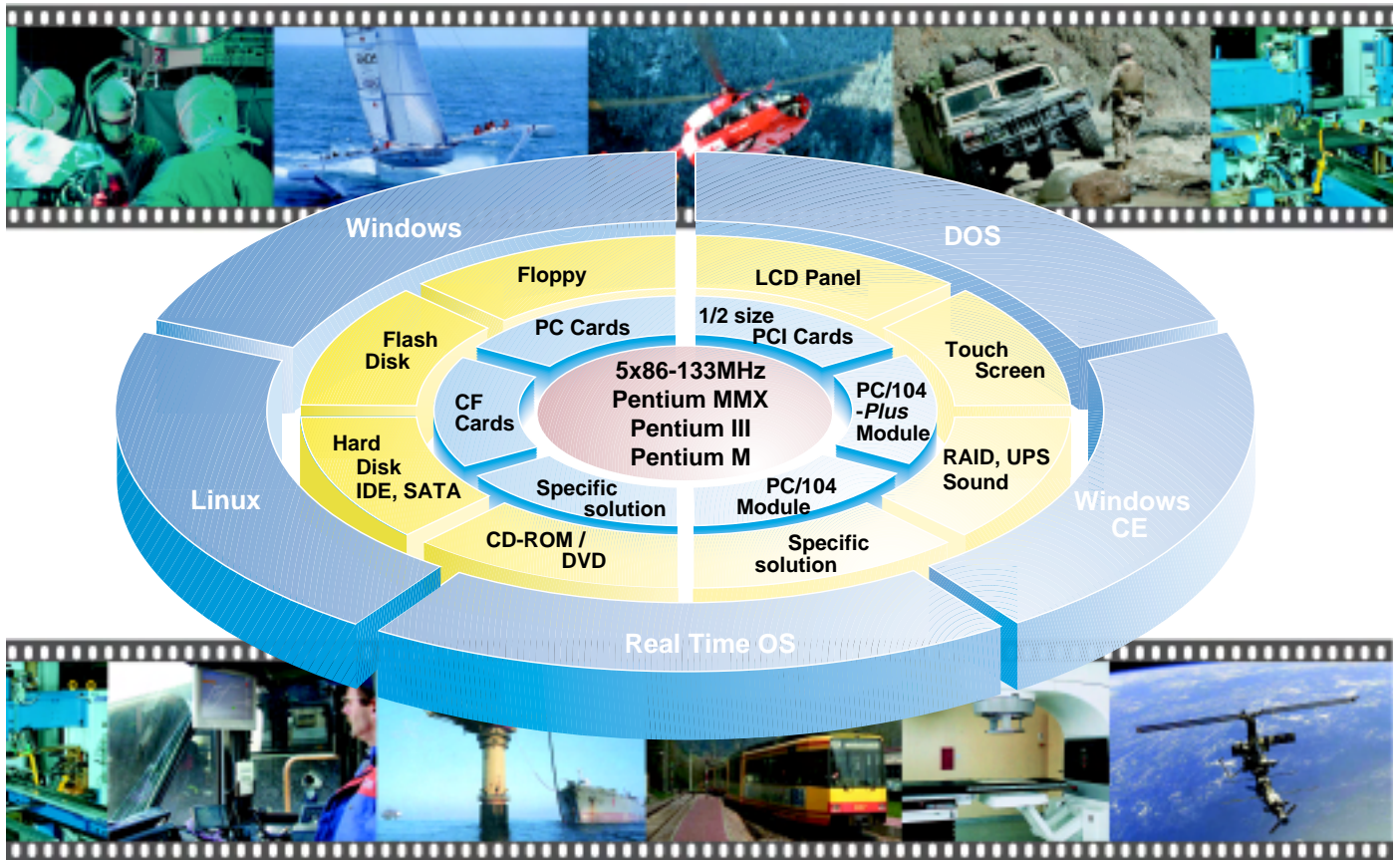

The PIP concept fits your custom specific solution!

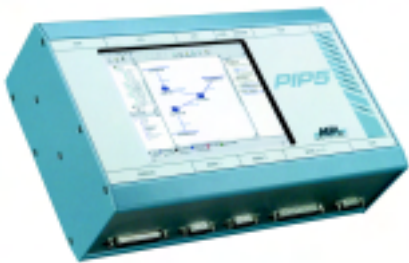

PIP5 with 6.4" XGA display and touch

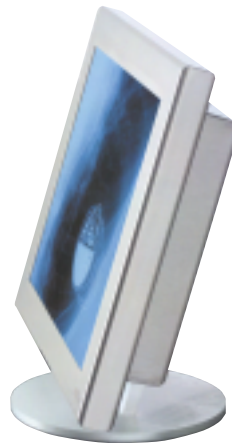

PIP9 in a stainless steel housing with 19" SXGA display



PIP8 with 12" XGA display and touch, all around IP65, fanless, noiseless



PIP7 with 2 standard PCI slots inside



OEM-PIP with lockable PC-Card slot



OEM-PIP assembled with up to 4 additional PC/104 cards



Täferstrasse 20  
 CH-5405 Baden-Dättwil  
 Tel. +41 (0)56 483 34 34  
 Fax +41 (0)56 493 30 20  
 Email: info@mpl.ch  
 Home page: www.mpl.ch